

Index

Arches	1,2
Frieze & Motifs	3,4
Balustrading	5
Eave Brackets	6
& Moulding	6
Corner Brackets	7
Finials & Rafters	8
Window Canopies	9
Verandah Posts	10,11
MDF Arches	12
Calder Vents	13
Fire Surrounds	14
Columns	15,16,17,18

PLEASE NOTE THESE PRICES DONOT INCLUDE GST

Arches



Delivery available to anywhere in Victoria POA

PLEASE NOTE THESE PRICES DONOT INCLUDE GST

Arches

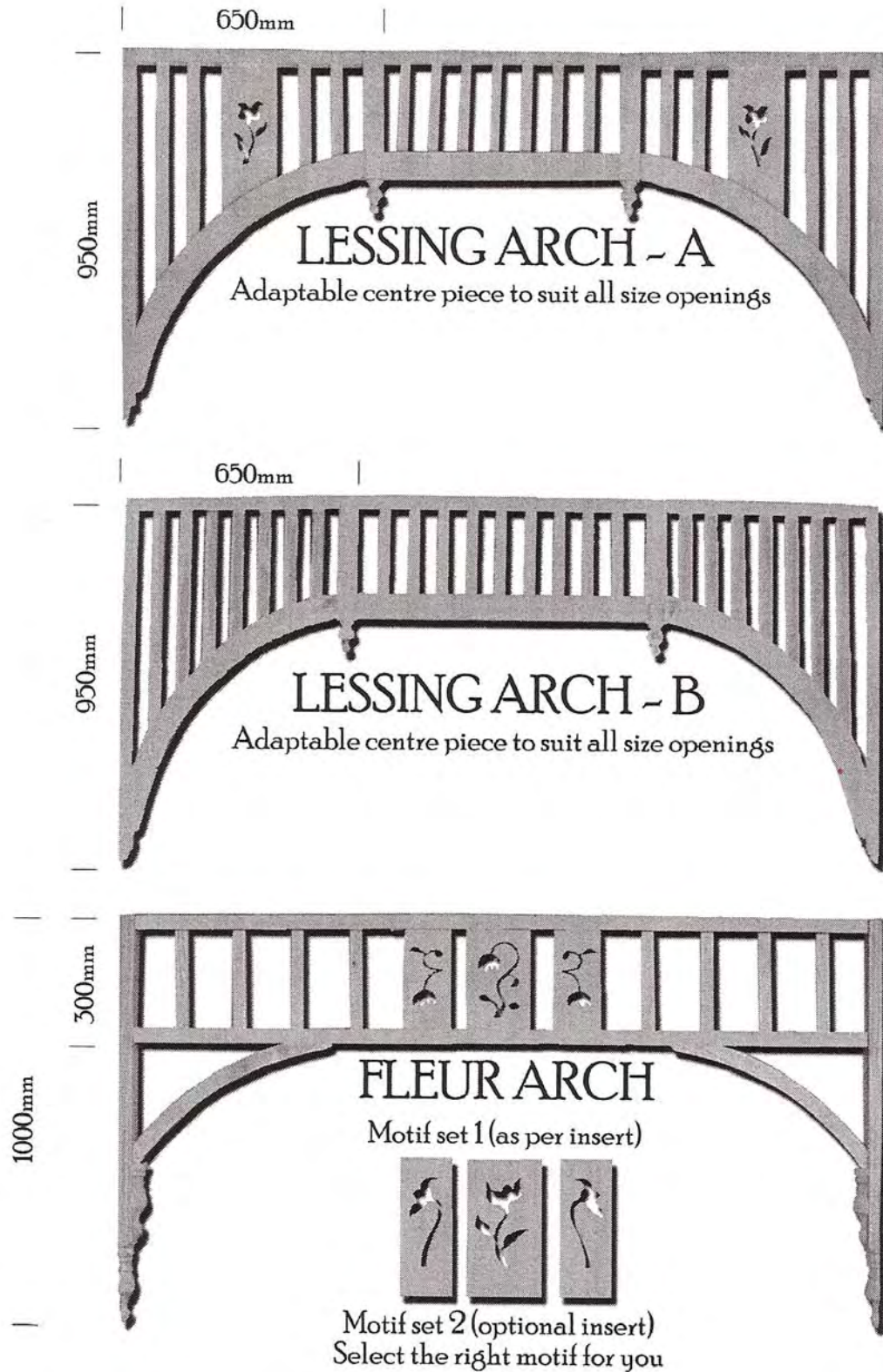

PLEASE NOTE THESE PRICES DONOT INCLUDE GST

Frieze & Motifs

Our extensive range of frieze work and internal/external arches provide endless style options. Pre-assembled using stable timbers and your choice of motifs, these charming components can be used to great effect on verandahs, entrances and hallways.

OPTIONAL MOTIFS IN FR2 & ARCHES



1



2



3

MOTIFS
1-5 90mm



4



5



6

MOTIF 6
140mm

TURNED DROPPERS

70mm

90mm

115mm

Custom designs made to order POA

PLEASE NOTE THESE PRICES DONOT INCLUDE GST

Frieze & Motifs

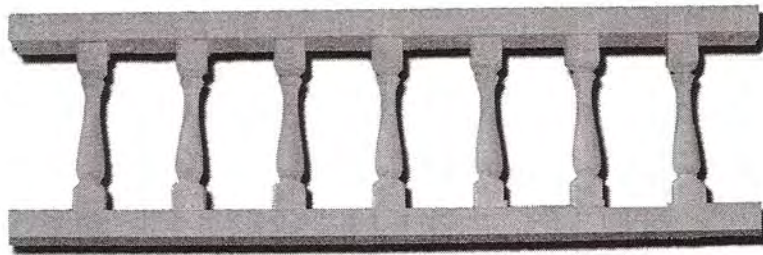
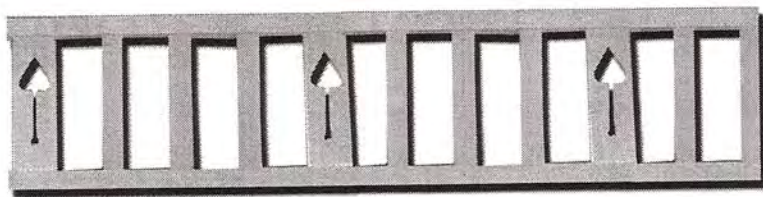
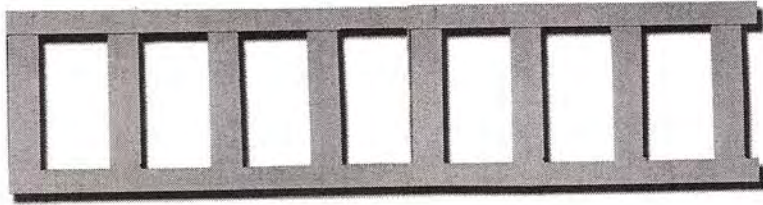

Height of frieze ~ 300mm Minimum charge ~ 15lm

MOTIF SET 1

MOTIF SET 2



Custom designs made to order POA

PLEASE NOTE THESE PRICES DONOT INCLUDE GST

Balustrading

All Balustrading Standard 950mm Overall Height



BAL-1



HR-1
90x70mm

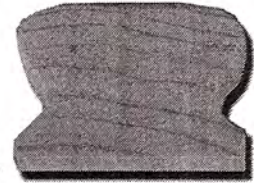

HR-2
45x70mm

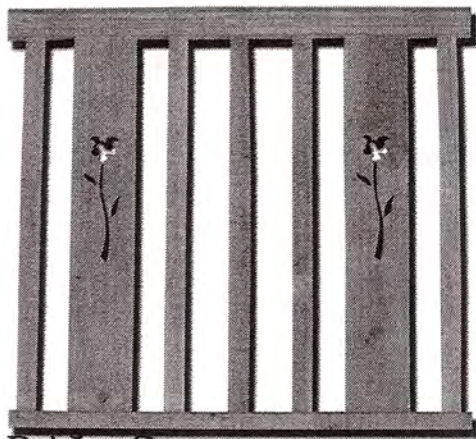

BAL-2

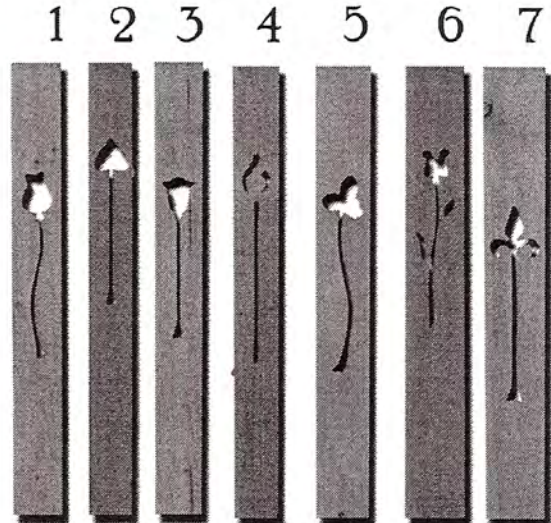

A B C D

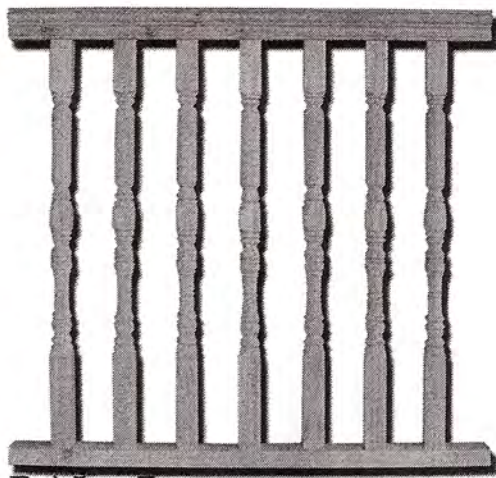

BAL-3

Pine
40x40

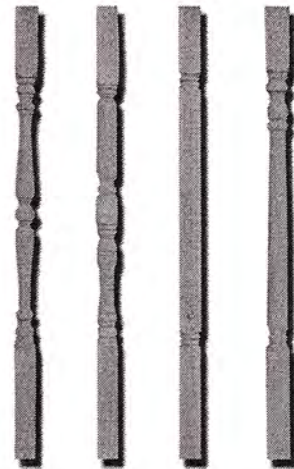

PLEASE NOTE THESE PRICES DONOT INCLUDE GST

Eave Brackets & Moulding

Our large range of corner and eave brackets provide for any decorative situation, an easy and delicate way to add elegance to a plain verandah. Internal use of corner brackets, when combined with frieze work or arches, can create stunning effects.

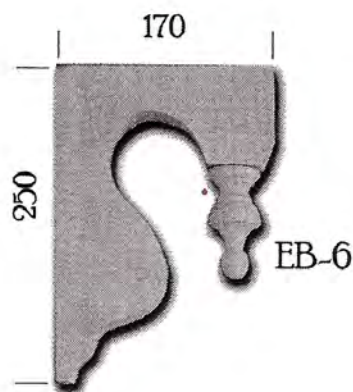
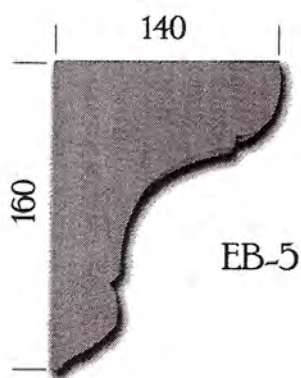
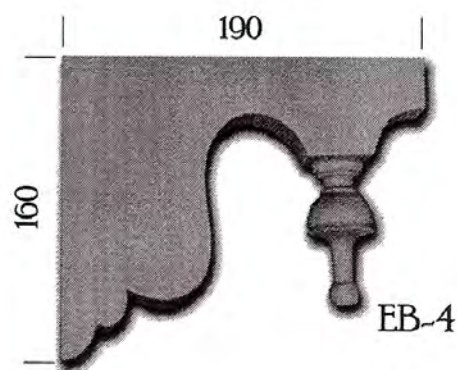
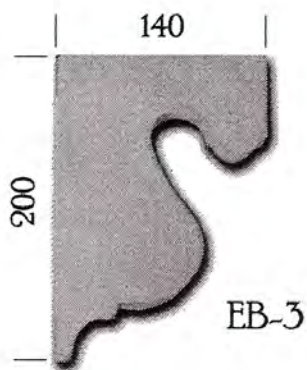
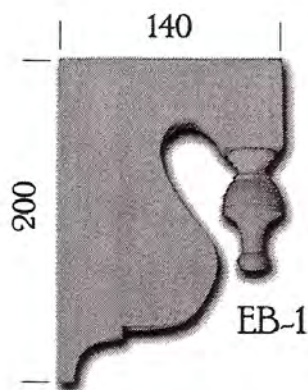

ROSETTES

90mm

110mm

CRICKET BAT MOULDING

Used between eave brackets 90x45mm



100mm. Minimum order 1m ~

PLEASE NOTE THESE PRICES DONOT INCLUDE GST

Corner Brackets

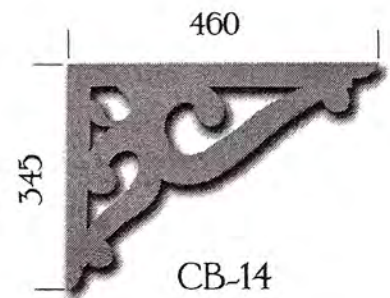
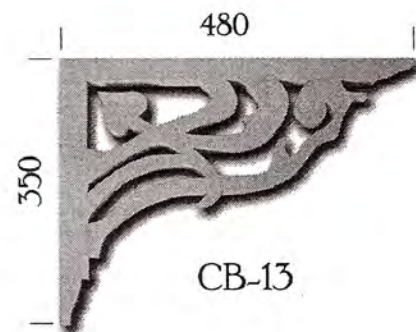
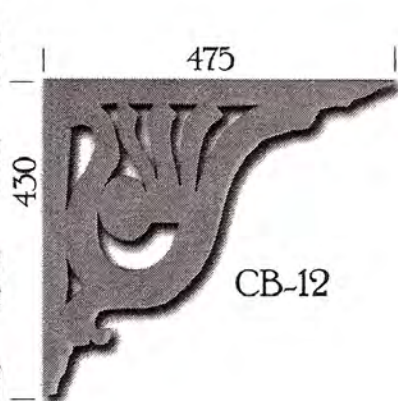
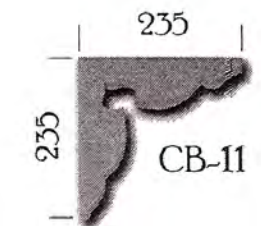
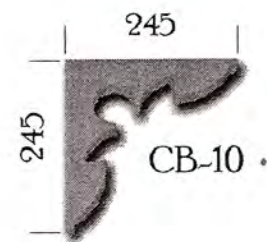
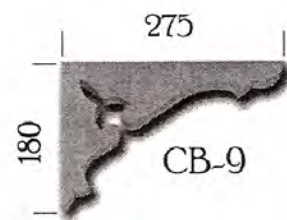
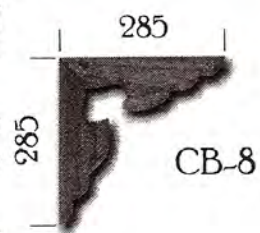
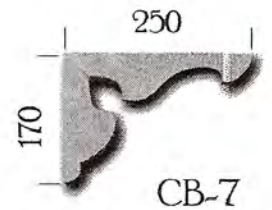
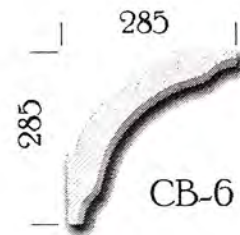
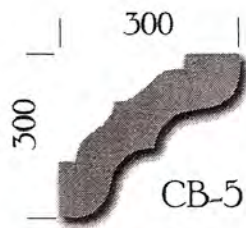
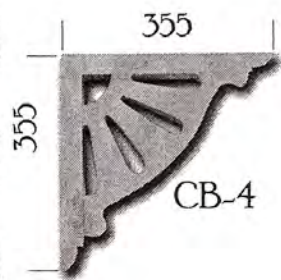
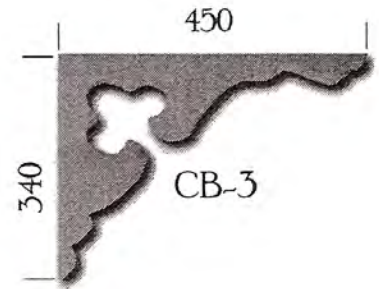
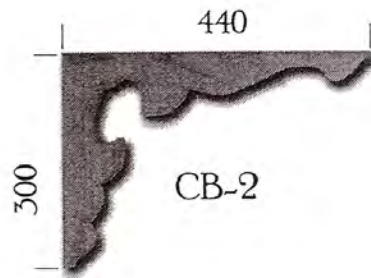
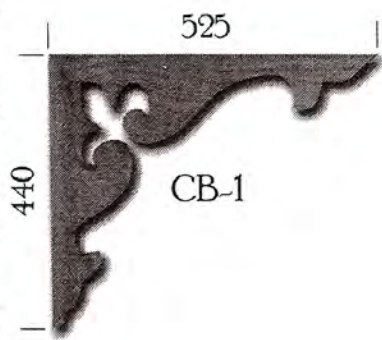

* All measurements shown are in mm.

PLEASE NOTE THESE PRICES DONOT INCLUDE GST

Finials & Rafter



F1 POINT



F1 BALL



F2 POINT



F2 BALL



F3

CONCAVE/CONVEX



BULLNOSE



OLD GOTHIC



PLEASE NOTE THESE PRICES DONOT INCLUDE GST

Window Canopies

Choice of motif for WC-1 & WC-4

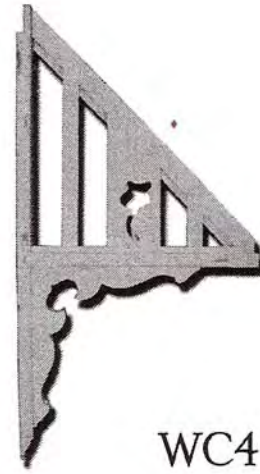
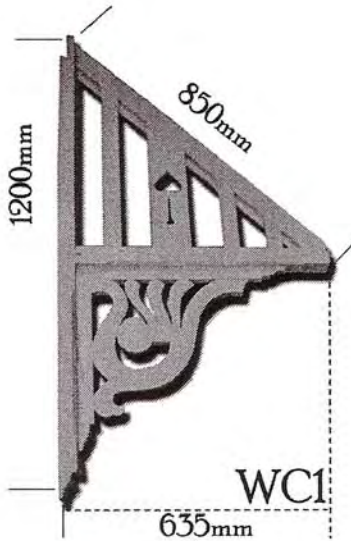

BARGE TRIM



FASCIA BOARD



PLEASE NOTE THESE PRICES DONOT INCLUDE GST

Verandah Posts

All posts have 700mm top or to your requirements.

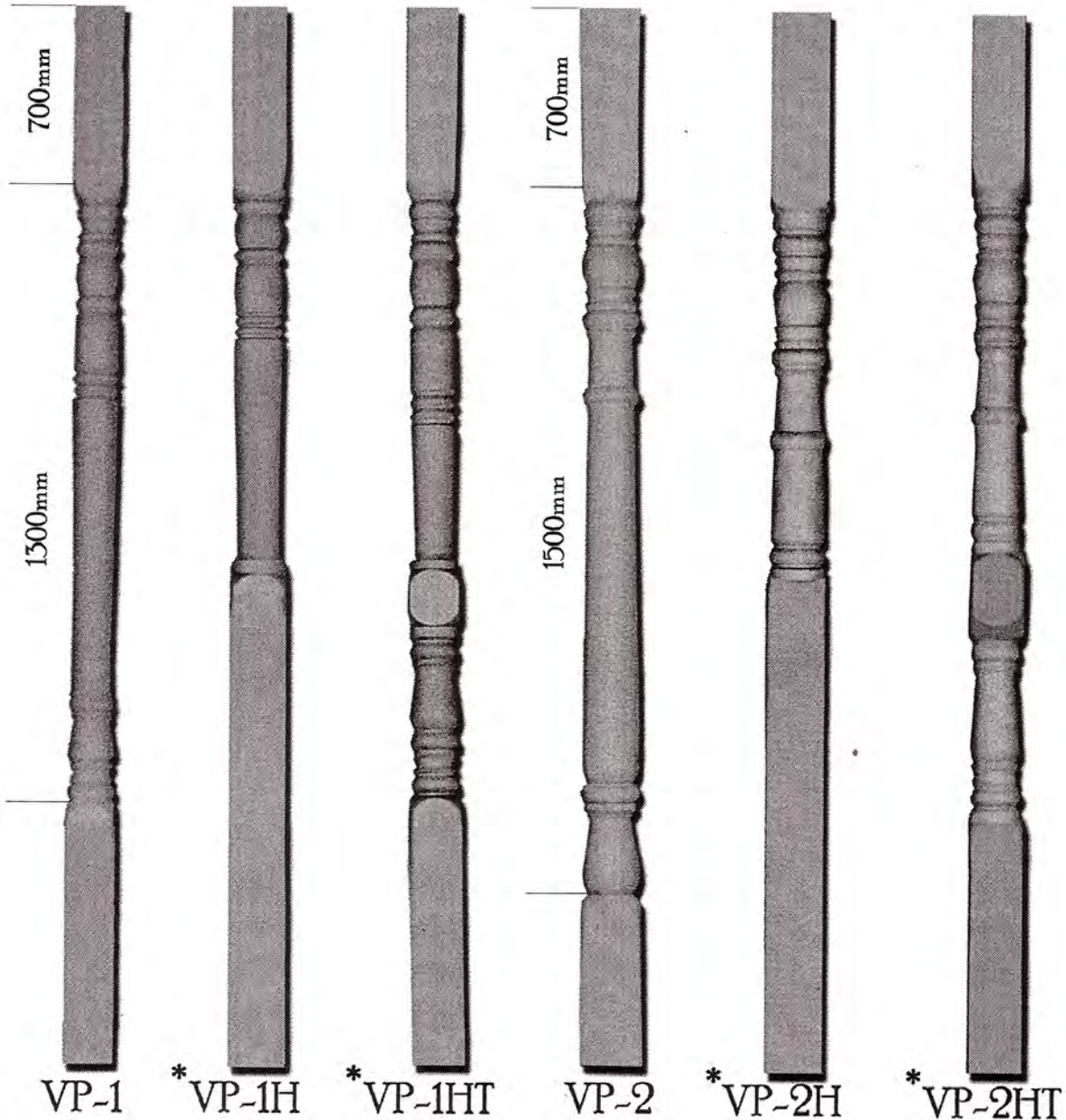

For Hand Rail posts * Square lengths and turned sections are variable to suit your requirements.

For VP1, VP2 & VP3 the following example applies:

A standard 2.4m VP1 post has top section 700, turned section 1300 and bottom section 400

Any increase in length occurs in bottom section

PLEASE NOTE THESE PRICES DONOT INCLUDE GST

Verandah Posts

All posts have 700mm top or to your requirements.
Standard sizes are an indication only, custom designs
can be made to suit your specifications.

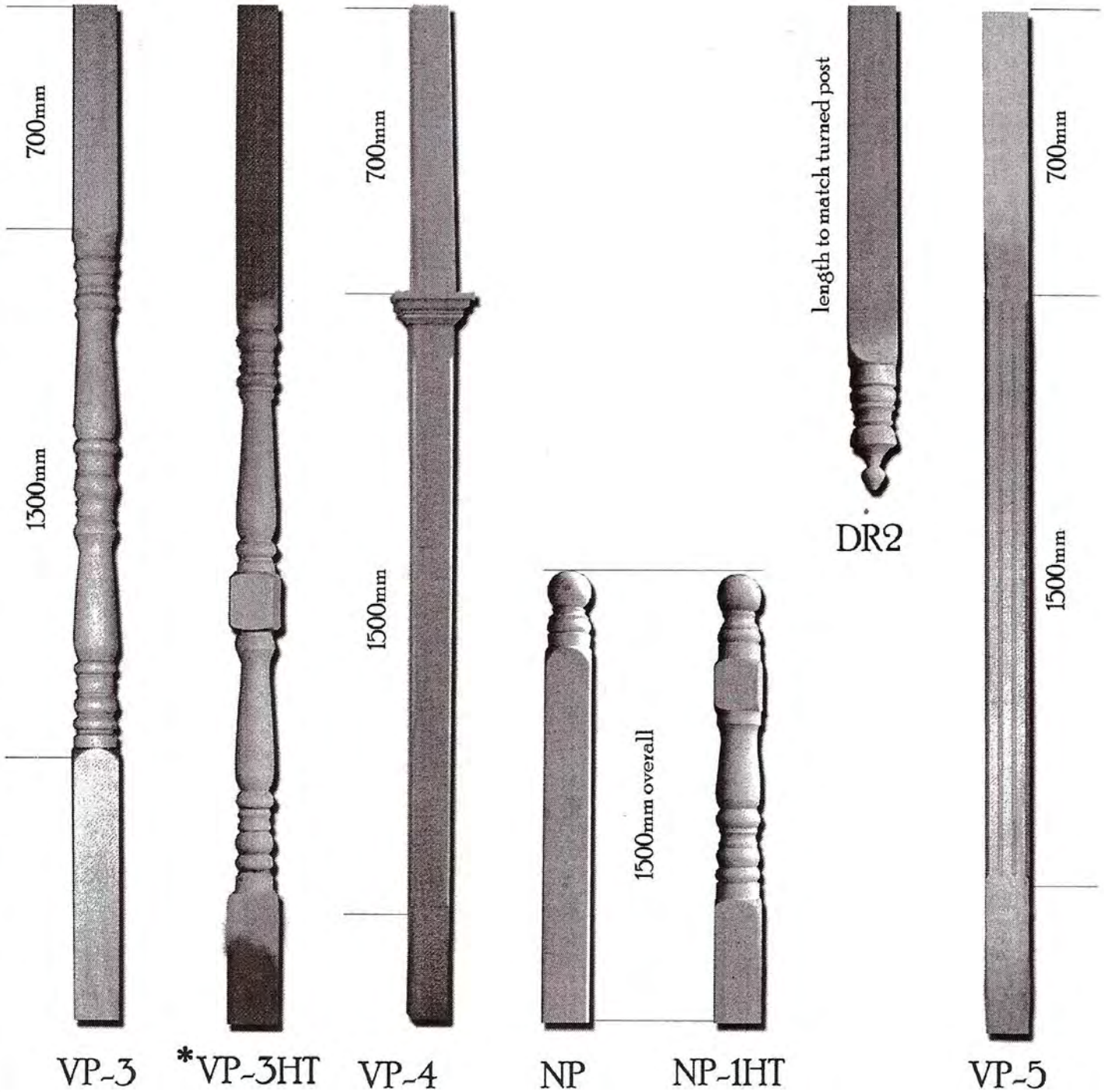

PLEASE NOTE THESE PRICES DONOT INCLUDE GST

M.D.F. Arches

WONTHAGGI



Up to 1400mm
1400mm+extensions
600mm
750mm
900mm
1200mm
1500mm
1800mm

BROOKFIELD



Up to 1400m
1400mm+extensions
600mm
750mm
900mm
1200mm
1500mm
1800mm

ORBOST



Up to 1800mm
1800mm+ POA

PLEASE NOTE THESE PRICES DONOT INCLUDE GST

Calder Vents

GABLE VENT

* Exterior Plywood Vents are 60mm thick, suitable for brickwork or FC sheeting

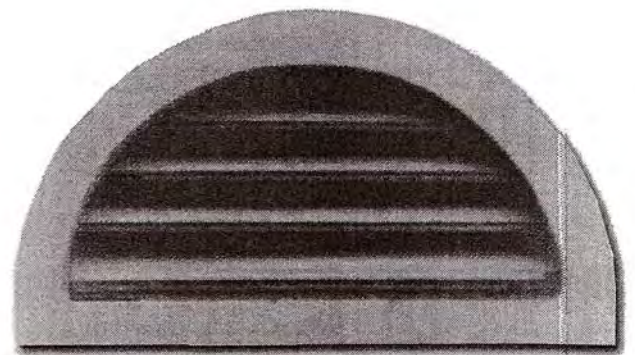
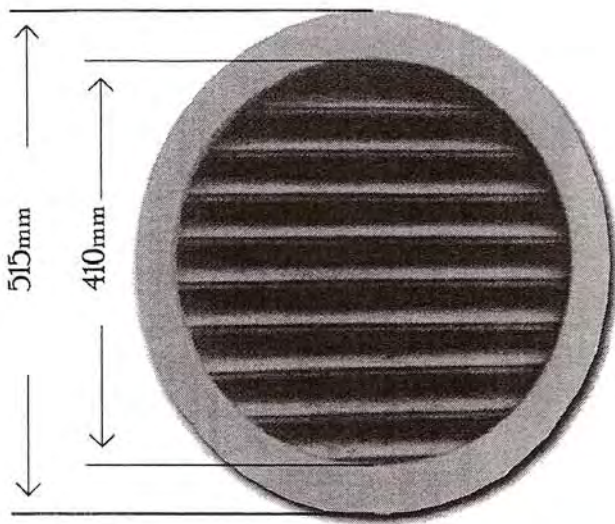

Made to Measure -POA



360mm

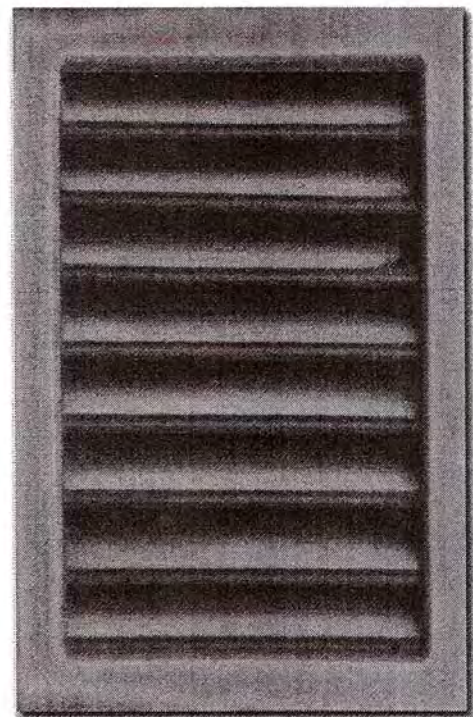

Made to Measure -POA

PLEASE NOTE THESE PRICES DONOT INCLUDE GST

Fire Surrounds

BENDIGO

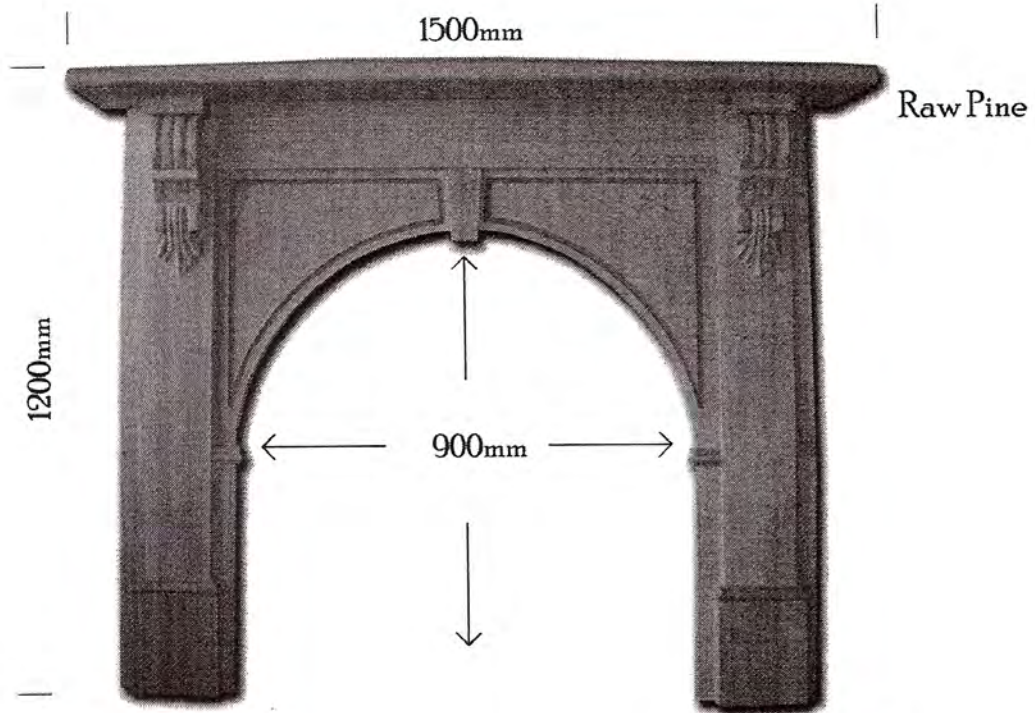

RICHMOND

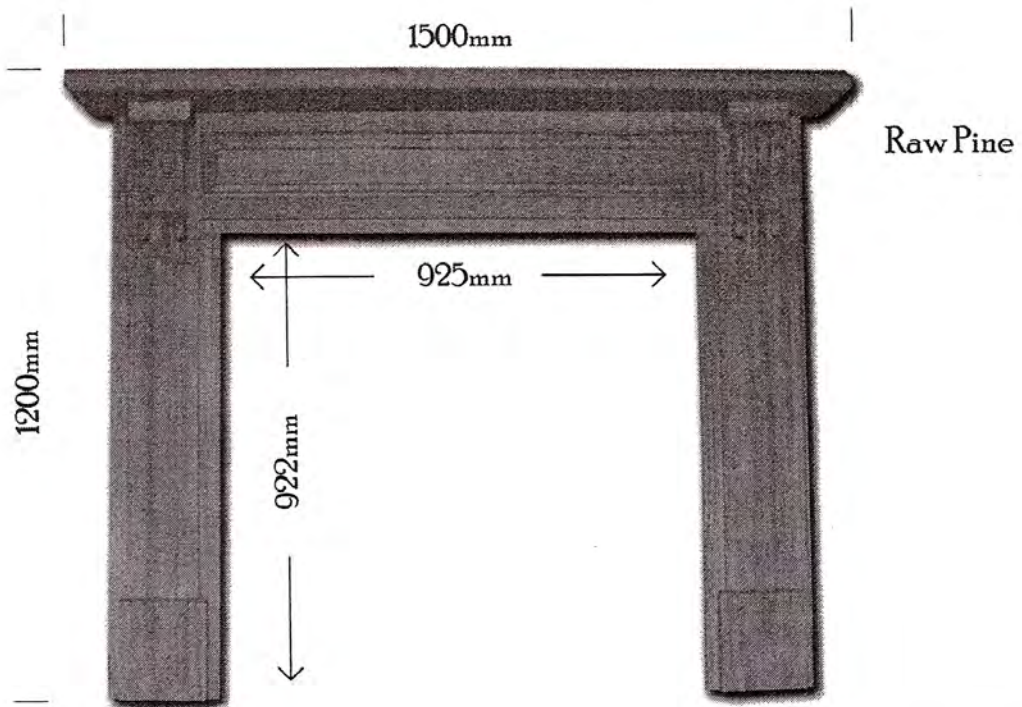

PLEASE NOTE THESE PRICES DONOT INCLUDE GST

Columns

CLASSIC

Introducing...

The Calder Range of specially designed architectural columns will bring a touch of class to your next project.

These architecturally designed, non-structural columns can be fitted at any time during construction, due to a removable panel.

Their innovative new design suits today's modern building styles.

Enhance your residential or commercial designs with these classic architectural forms.

We can advise before and during construction, on how to achieve your specific requirements.

Calder Columns are available to suit your individual requirements.

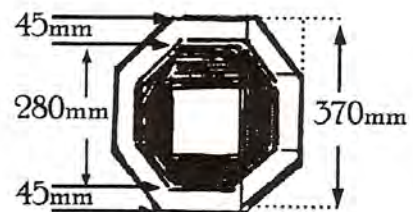
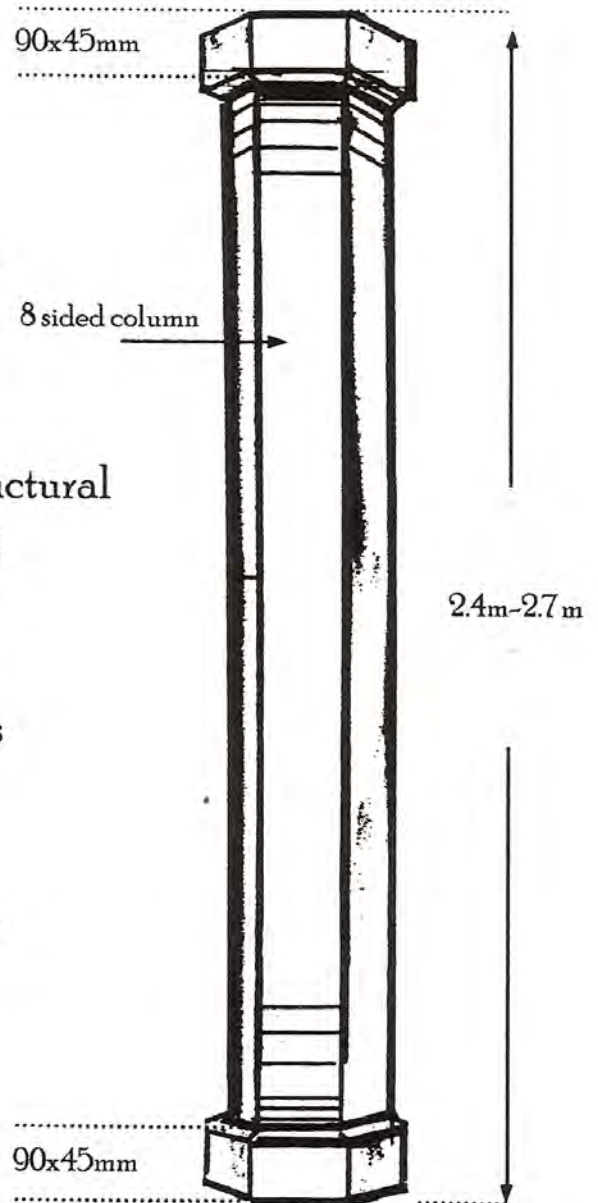

PLEASE NOTE THESE PRICES DONOT INCLUDE GST

Columns

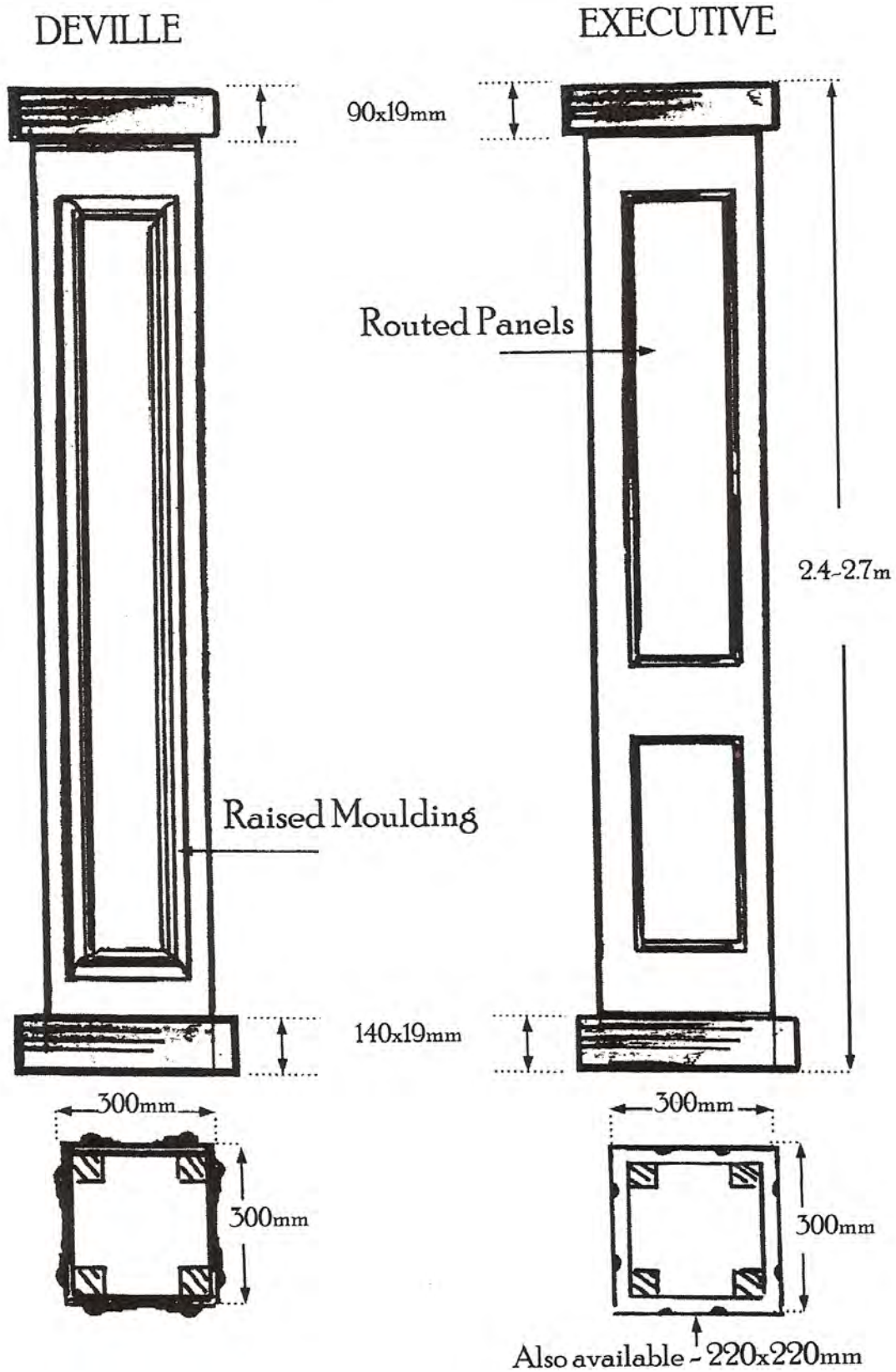

PLEASE NOTE THESE PRICES DONOT INCLUDE GST

Columns

THE COMMODORE

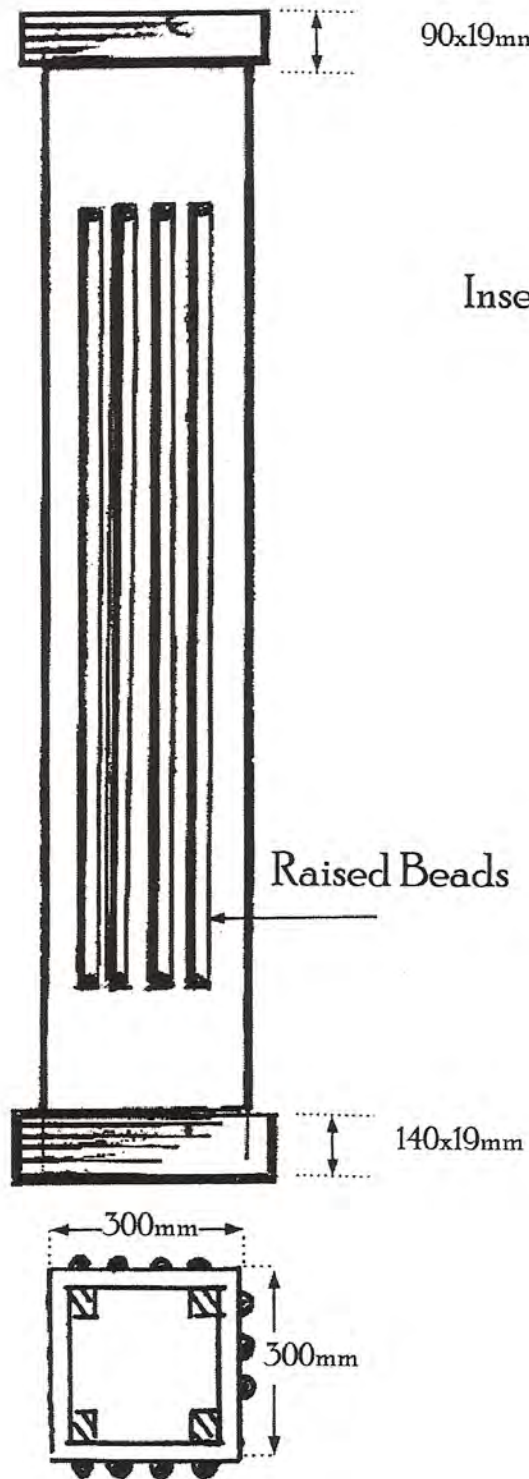

STATESMAN

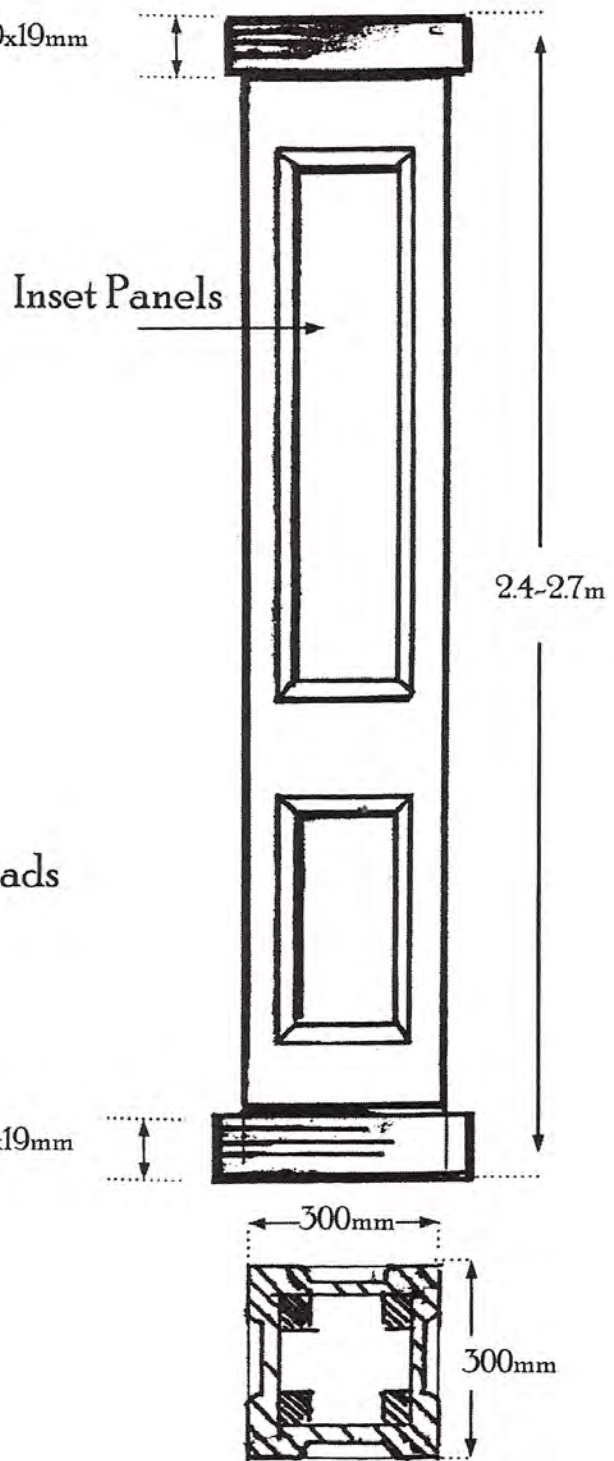

PLEASE NOTE THESE PRICES DONOT INCLUDE GST

Columns

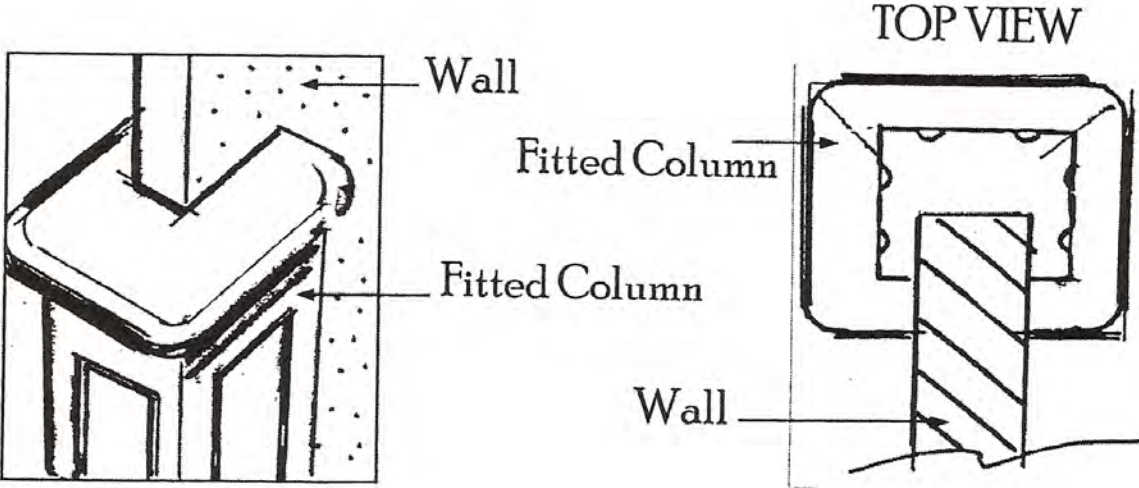
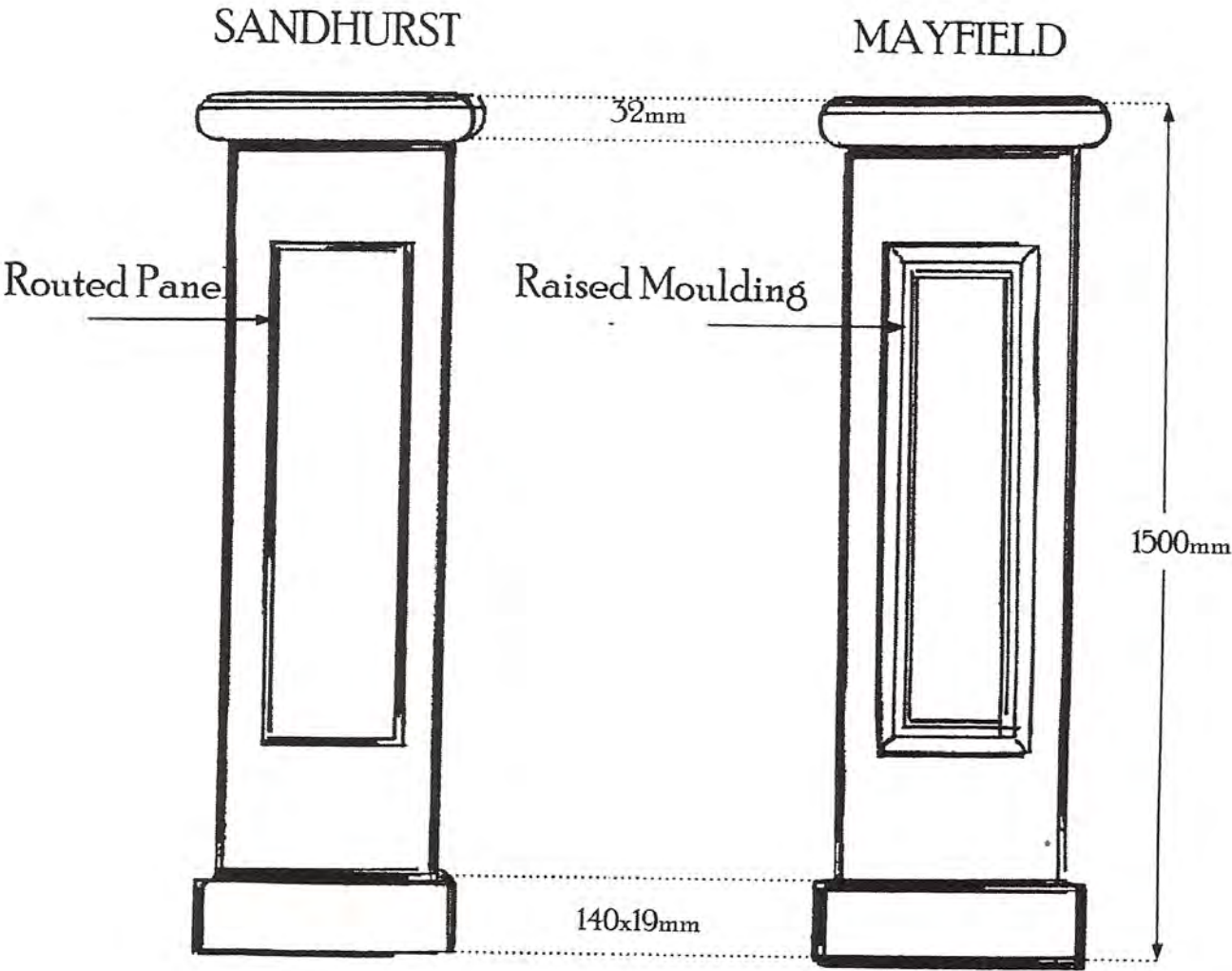

PLEASE NOTE THESE PRICES DONOT INCLUDE GST